

## Shelves (Fixed) - Panel Mount (Single Pair of Panel Rails)

Path: [Home](#) > [Rack Index](#) > Shelves (Fixed) - Panel Mount

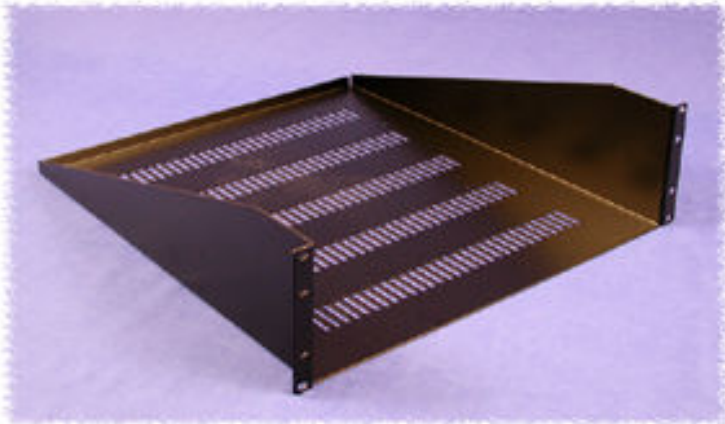

**Vented**  
(20" Deep - 3U Shown)

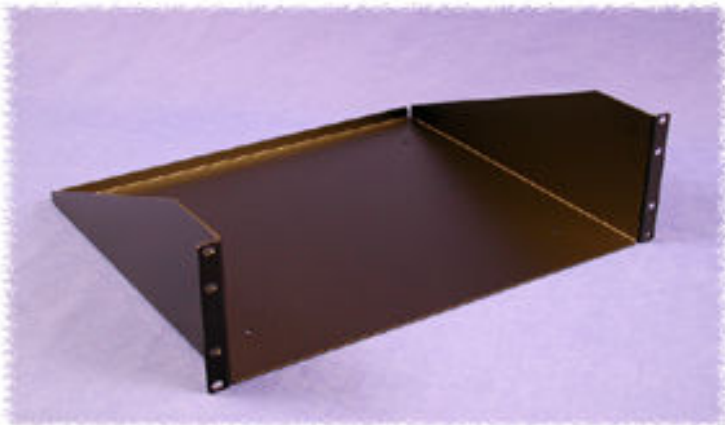

**Unvented**  
(15" Deep - 3U Shown)

### Panel Rail Mounted Fixed Chassis/Shelf (Vented or Unvented)

- Shelves feature formed 14-gauge steel construction
- Choice of four heights - 1.75"(1U), 3.5"(2U), 5.25"(3U) or 7"(4U) of panel space
- Rear lip folded up for extra strength & acts as a rear equipment retainer
- Weight load tested: (1U-40 pounds, 2U-100 pounds, 3U & 4U-200 pounds)
- Mounts to front rail either as an internal shelf or external shelf/work area
- Choice of two depths - 15" or 20"
- Available in either vented or unvented versions
- Rugged powder paint finish
- Requires mounting [hardware](#)



[Assembly  
Instructions](#)

## VENTED

Part Number	Color	Paint Texture	Panel Height				AutoCAD .dxf File (zipped)	.zip File Size	Panel Width	Shelf Depth
			Inches	Units						
<b>19" Rack Mount</b>										
<b>RASV190115BK1</b>	Black	Textured	<b>1.75</b>	1		63K		57K	<b>19"</b>	15"
<b>RASV190120BK1</b>	Black	Textured	<b>1.75</b>	1		73K		68K	<b>19"</b>	20"
<b>RASV190315BK1</b>	Black	Textured	<b>3.50</b>	2		66K		57K	<b>19"</b>	15"
<b>RASV190320BK1</b>	Black	Textured	<b>3.50</b>	2		73K		68K	<b>19"</b>	20"
<b>RASV190515BK1</b> <b>RASV190515CG1</b>	Black Grey/ Beige	Textured Textured	<b>5.25</b>	3		35K		54K	<b>19"</b>	15"
<b>RASV190520BK1</b> <b>RASV190520CG1</b>	Black Grey/ Beige	Textured Textured	<b>5.25</b>	3		39K		62K	<b>19"</b>	20"
<b>RASV190715BK1</b>	Black	Textured	<b>7.00</b>	4		62K		52K	<b>19"</b>	15"
<b>RASV190720BK1</b>	Black	Textured	<b>7.00</b>	4		70K		60K	<b>19"</b>	20"
<b>23" Rack Mount</b>										
<b>RASV230515BK1</b>	Black	Textured	<b>5.25</b>	3		42K		65K	<b>23"</b>	15"
<b>RASV230520BK1</b>	Black	Textured	<b>5.25</b>	3		49K		77K	<b>23"</b>	20"
<b>24" Rack Mount</b>										
<b>RASV240515BK1</b>	Black	Textured	<b>5.25</b>	3		45K		65K	<b>24"</b>	15"
<b>RASV240520BK1</b>	Black	Textured	<b>5.25</b>	3		48K		78K	<b>24"</b>	20"

## UNVENTED



PART No. RASV230520

ISOMETRIC VIEW NOT TO SCALE

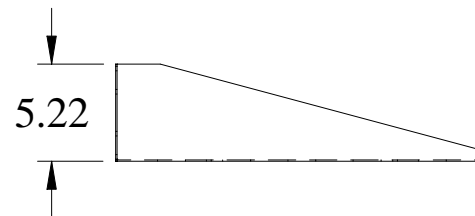
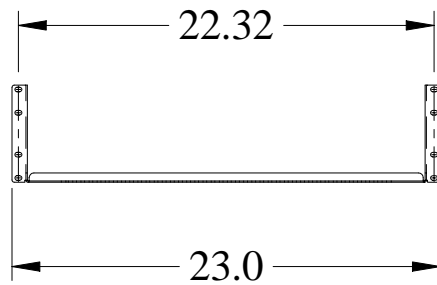
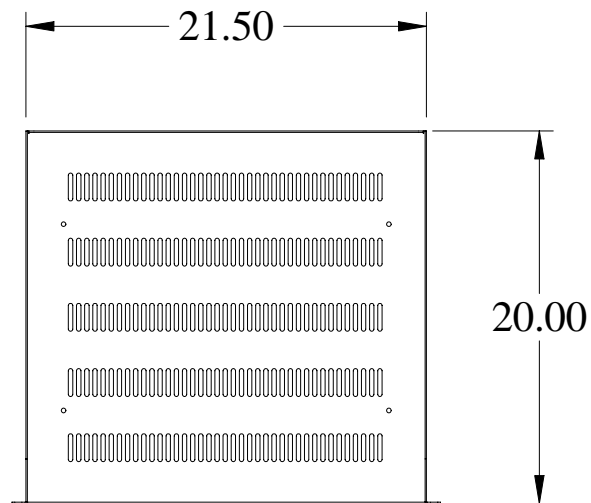
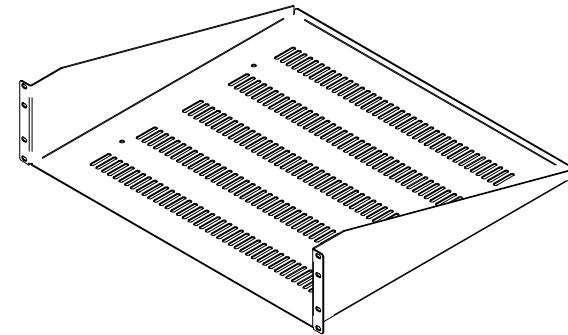

## RAIL MOUNT - DUAL MODEM SHELVES

- Standard 19" rack mount - overall 19.5" deep, uses 3.5" (2U) of panel space
- Dual modem shelf permits front and rear access to modems on open relay racks
- 16 gauge steel construction, weight load tested to 200 pounds
- The vented version provides a sturdy shelf without obstructing upward heat movement
- Rugged powder paint finish
- Requires mounting hardware

### Unvented

Part Number		Panel Width
Black Textured	Grey Smooth	
<a href="#">DNDMS19BK1</a>	<a href="#">DNDMS19GY2</a>	19"
<a href="#">DNDMS23BK1</a>	-	23"



### Vented

Part Number		Panel Width
Black Textured	Grey Smooth	
<a href="#">DNDMV19BK1</a>	<a href="#">DNDMV19GY2</a>	19"

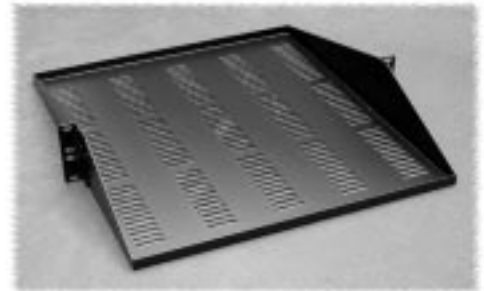

## RAIL MOUNT SHELVES

- Standard 19" rack mount - rail mount
- 17.25" wide and uses 5.25" (3U) of panel space, choice of two depths, either 15" or 20"
- Rear lip folded up for extra strength & acts as a rear equipment retainer
- 14 gauge steel construction, weight load tested to 200 pounds (unvented), 200 pounds (vented)
- Mounts to front rail either as an internal shelf or external shelf/work area
- The vented version provides a sturdy shelf without obstructing upward heat movement
- Rugged powder paint finish
- Requires mounting hardware

### Unvented

Part Number			Panel Width	Shelf Depth
Black Textured	Beige Textured	Grey Smooth		
<a href="#">RASU190515BK1</a>	<a href="#">RASU190515CG1</a>	<a href="#">RASU190515GY2</a>	19"	15"
<a href="#">RASU190520BK1</a>	<a href="#">RASU190520CG1</a>	-	19"	20"
<a href="#">RASU230515BK1</a>	-	-	23"	15"
<a href="#">RASU230520BK1</a>	-	-	23"	20"



### Vented

Part Number			Panel Width	Shelf Depth
Black Textured	Beige Textured	Grey Smooth		
<a href="#">RASV190515BK1</a>	<a href="#">RASV190515CG1</a>	<a href="#">RASV190515GY2</a>	19"	15"
<a href="#">RASV190520BK1</a>	<a href="#">RASV190520CG1</a>	-	19"	20"
<a href="#">RASV230515BK1</a>	-	-	23"	15"
<a href="#">RASV230520BK1</a>	-	-	23"	20"

